



MARBACH

MARBACH SERVICES.

360° SERVICE FROM THE EXPERTS.

**PACKAGING.
PERFORMANCE.
YOU.**

English



PROLOGUE.

Marbach services. 360° service from the experts.

PERFORMANCE.

Your maximum performance is our objective. From the start. This is precisely why we offer you not only tools. But also a wide range of services. From the idea. To the product. For smooth manufacturing processes. Efficiency in your production. Professionally trained employees. And perfect packaging at the point of sale.

Benefit from Marbach know-how. And from almost 100 years of experience.

SERVICES.

Our 360° service offers you the following:

Packaging design services.

Whether you need support in CAD design based on samples or the development of a new packaging from scratch. We provide you with the necessary service. Competently. And safely. So you can focus entirely on your core business.

Sampling services.

We can produce different samples for you. For packaging and filling tests. So you can use your full capacity for production orders.

Tool services.

For perfect results you need perfect tools. We manufacture test tools for you. We test them. And optimize them. We also examine your production tools. And point out optimization potential. For the best performance in your production.

Process optimization. Service worldwide.

Our specialists visit you on site. Optimize your processes together with you. Train your employees. And help you to increase your performance.

Digitization. And industry 4.0.

In the age of industry 4.0, we lead the way as innovation drivers. With our digital solutions for thermoforming processes and services. CONNECT|M. For intelligent tools. And CONNECT|AR. For intelligent service.

Use our large range of services. For your success. Have we aroused your curiosity? Then get in touch with your Marbach contact person. Or send an email to toolservice@marbach.com.

PA
C
KA
GI
NG.

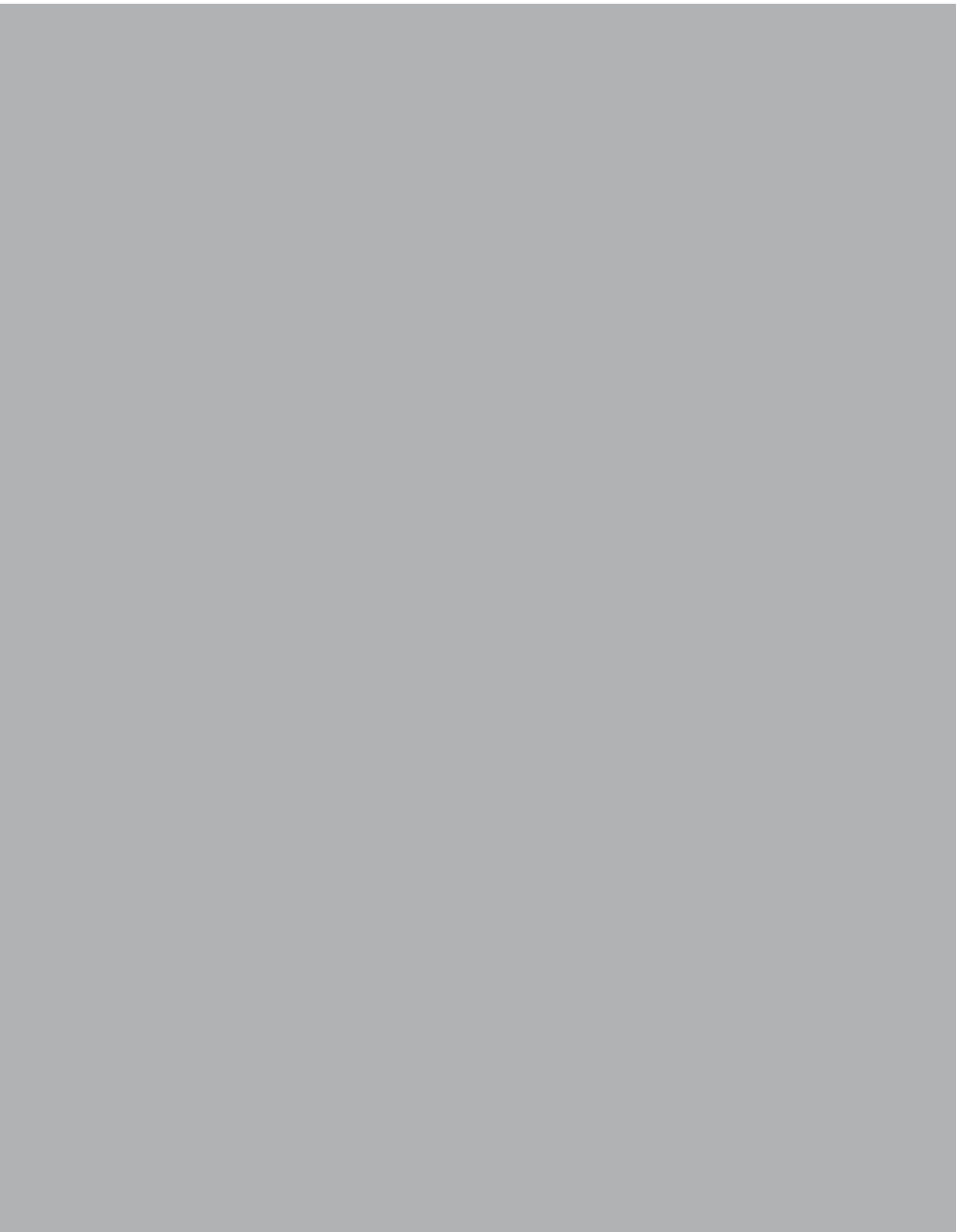

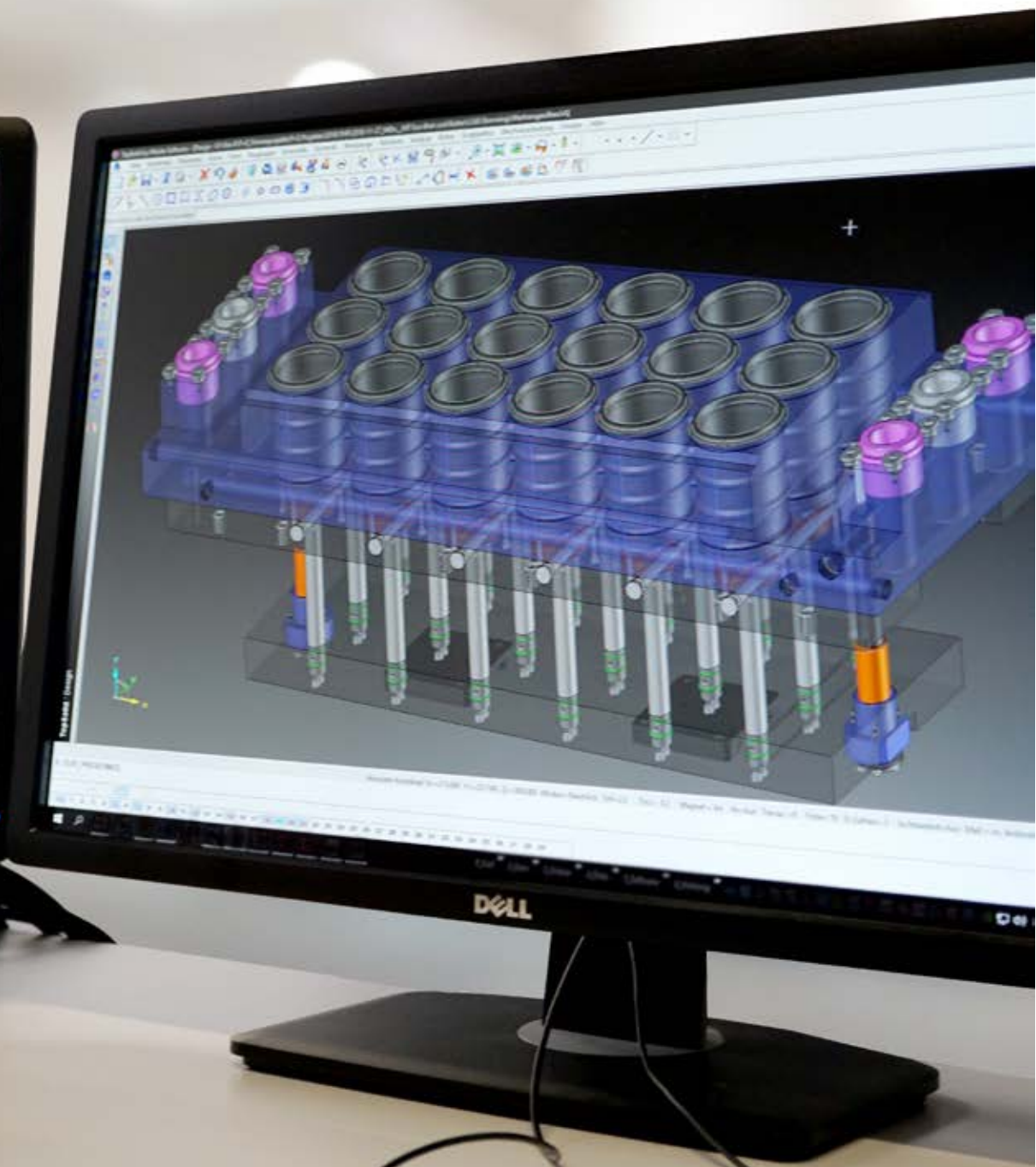
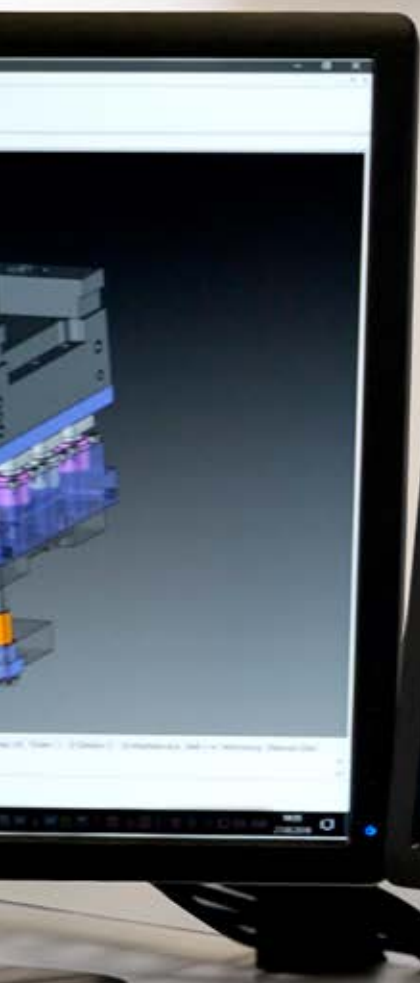

PACKAGING SERVICES.

DESIGN ACCORDING TO SAMPLE.

You have a packaging sample. But no design for it? Our experienced employees will support you. Simply supply us with the idea, the packaging or the tool. And we supply you with the data. Fast and easy.

Choose suitable options for your design.

- Design according to samples.
- Measuring of article samples.
- Reverse engineering: digitalization of pre-stretch plugs, moulded parts or any other tool component. With our 3D scanner.

Why you should use our service.

- We implement your ideas and requirements competently.
- You benefit from our many years of experience.
- We deliver all necessary data to you.
- You secure the data availability. Independently of the supplier.

We take over the creation of the data for you. So you can concentrate on your core business. Benefit from the know-how of the Marbach design experts.

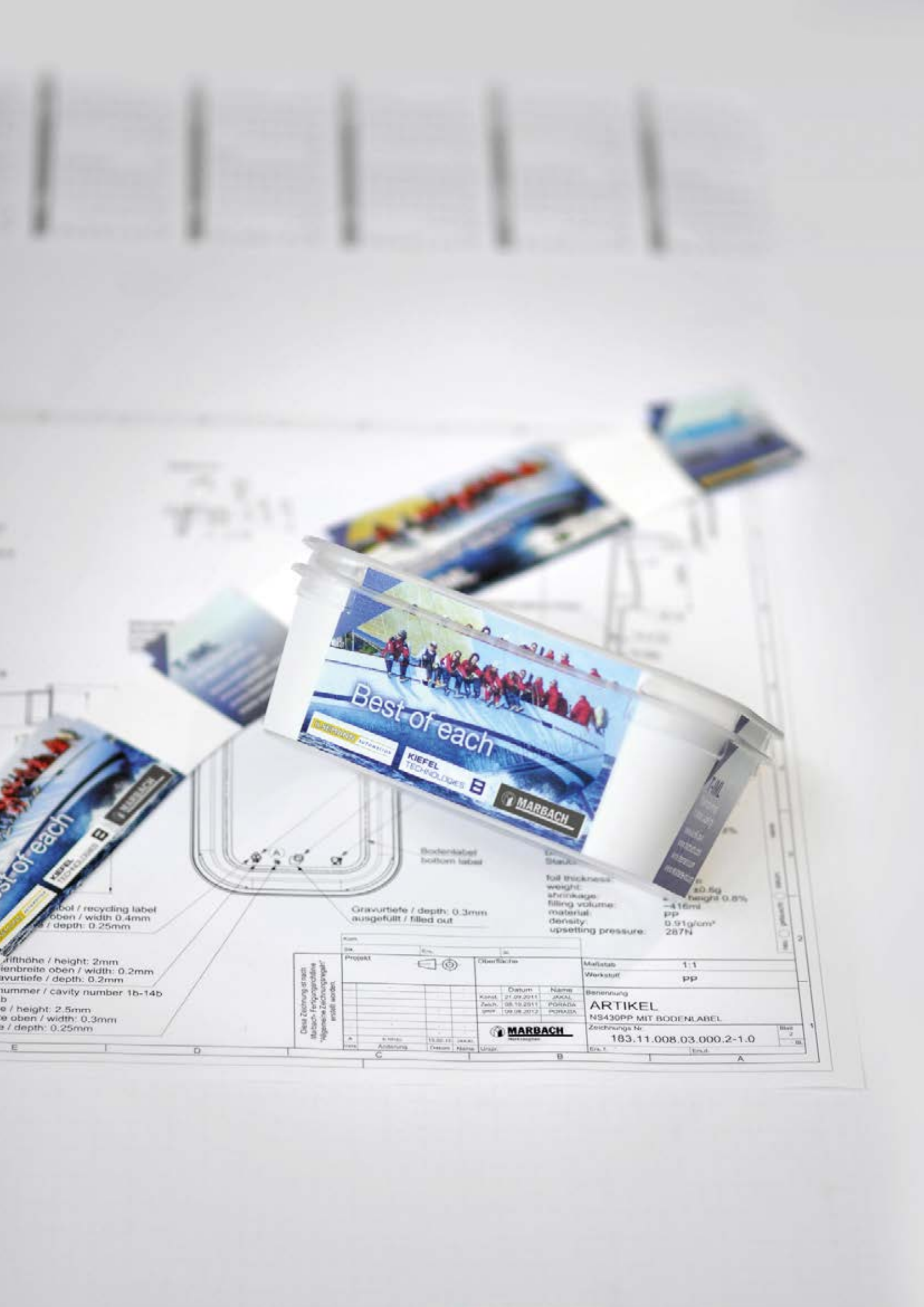

Bodenlabel
bottom label

Gravvertiefe / depth: 0.3mm
ausgefüllt / filled out

fol thickness: 0.16mm
weight: 1.8g
shrinkage: -4.16mm
filling volume: 1.8g
material: PP
density: 0.91g/cm³
upsetting pressure: 287N

Recyclinglabel / recycling label
Breite oben / width: 0.4mm
Tiefe / depth: 0.25mm
Gravvertiefe / height: 2mm
Gravvertiefe oben / width: 0.2mm
Gravvertiefe / depth: 0.2mm
Gravvertiefe / cavity number 1b-14b
Gravvertiefe / height: 2.5mm
Gravvertiefe oben / width: 0.3mm
Gravvertiefe / depth: 0.25mm

Kunde		Date		Lfd. Nr.	
Projekt		Oberfläche		Maßstab 1:1	
				Werkstoff pp	
Diese Zeichnung ist nach Marbach-Verfahren hergestellt worden.		Datum	Name	Benennung	
		21.09.2011	JAKAL	ARTIKEL	
		08.10.2011	PORADA	NS430PP MIT BODENLABEL	
		09.08.2012	PORADA	Zeichnungs-Nr.	
				183.11.008.03.000.2-1.0	
A	B	C	D	E	F
A		B		A	

PACKAGING SERVICES.

ARTICLE DEVELOPMENT.

You have a great idea for packaging? We are happy to support you in the development of your packaging. Explain to us your requirements and preferences. And our experts will develop the right packaging for you.

We don't just develop packaging that perfectly matches your requirements. But also create samples. Or test tools. Depending on your requirements.

Choose the suitable options for your packaging development.

- Development of packaging by product (packaged goods).
- Development of packaging according to an idea (e.g. packaging template).
- Sampling service (see page 11).

Why you should use our service.

- We realize your ideas and requirements competently.
- You benefit from our many years of experience.
- We don't just develop packaging. We also create samples. And always have an eye on the technical feasibility of the tool as well. This saves you time. And resources.
- You receive everything from a single source and thus save on coordination effort.

Development of packaging. And sample production. Benefit from this very special Marbach service.

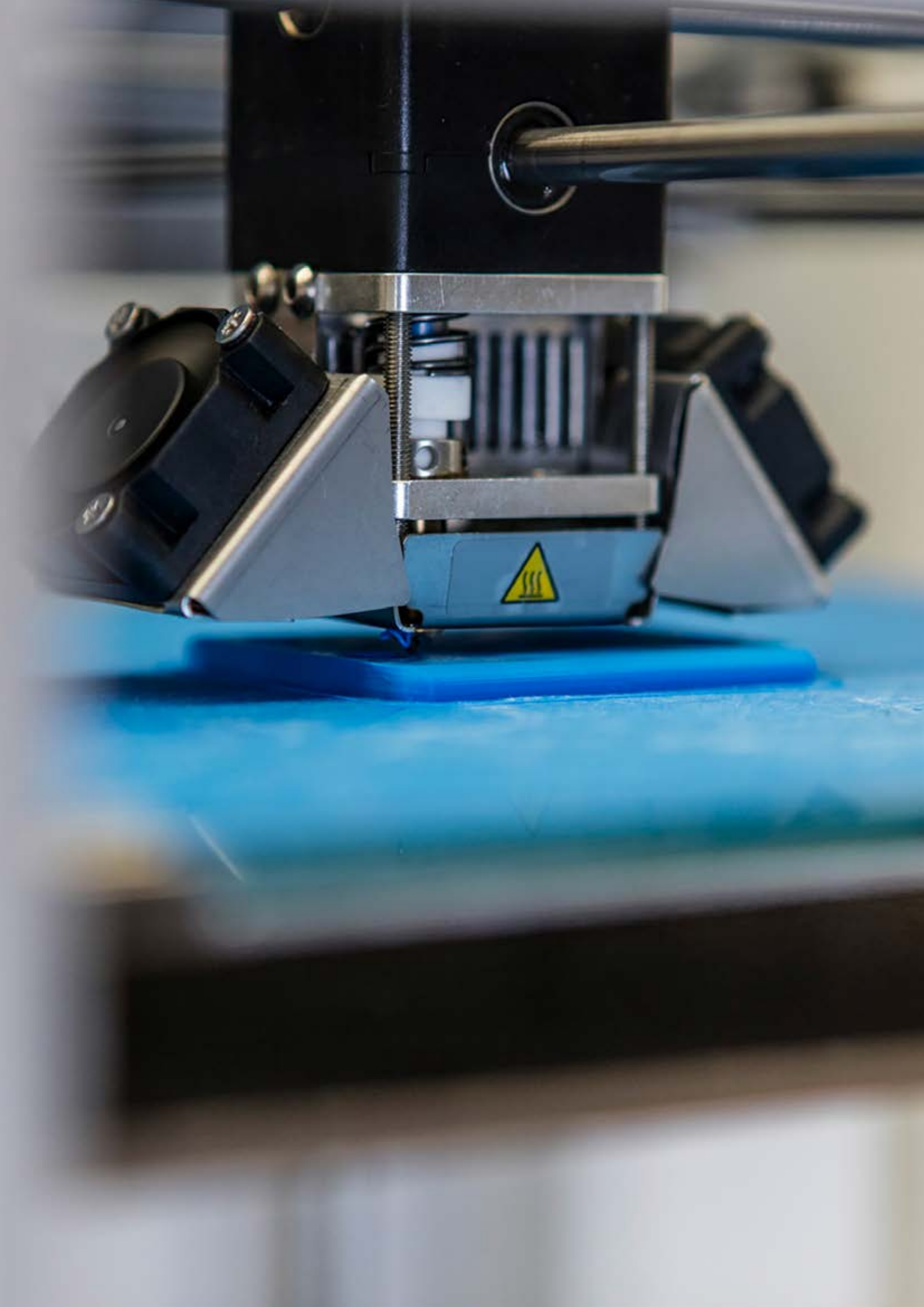

PACKAGING SERVICES.

SAMPLING SERVICE.

You need article samples? We have a modern machine park at our location in Heilbronn (see page 27). This enables us to produce single samples or whole pre-series for you. For filling tests. Stack tests. Retort tests. Seal tests. And many more.

Choose suitable options for your sample.

- Simple sample in 3D printer.
- Sample with approx. 60% originality* in vacuum former.
- Sample with 100% originality*. With a Marbach 1-up test tool.
- Sample for T-IML applications.

Why you should use our service.

- For perfect packaging.
- The optimal solution for packing and filling tests.
- You can use your machine capacities for your own production orders.

Play it safe. We support you with your sample making.

*Compared to the production tool.



SERVICES.

TEST TOOLS.

You are producing new packaging and want to make the production process as efficient as possible? You would like to test the tool extensively beforehand?

We will gladly support you with tests. Show you which factors matter. And produce a test tool for you. We advise you on topics such as technical feasibility. Productivity. And process reliability for 24/7 production. The quality of the individual products. Lid fit. We optimize the test tool and its components. And create a solid basis for your perfect production tool.

Choose suitable options for your test tool.

- Production of the test tool.
- Start-up of the test tool. Functionality tests in a production environment.
- Analysis and optimization of the test tool. Functionality. Process reliability. Stackability. Lid fit.
- Pre-stretch plug optimization. Material distribution in your product.

Why you should use our service.

- You receive know-how from a specialist in thermoforming.
- You can increase the efficiency of your production.
- To make sure in advance that the tool functions as desired.
- To optimize your productivity.
- You get everything from a single source and thus save valuable coordination effort.

Production, testing and optimization of test tools. Benefit from the technologies and expertise of the thermoform expert Marbach.

PER
FOR
MA
N
CE.

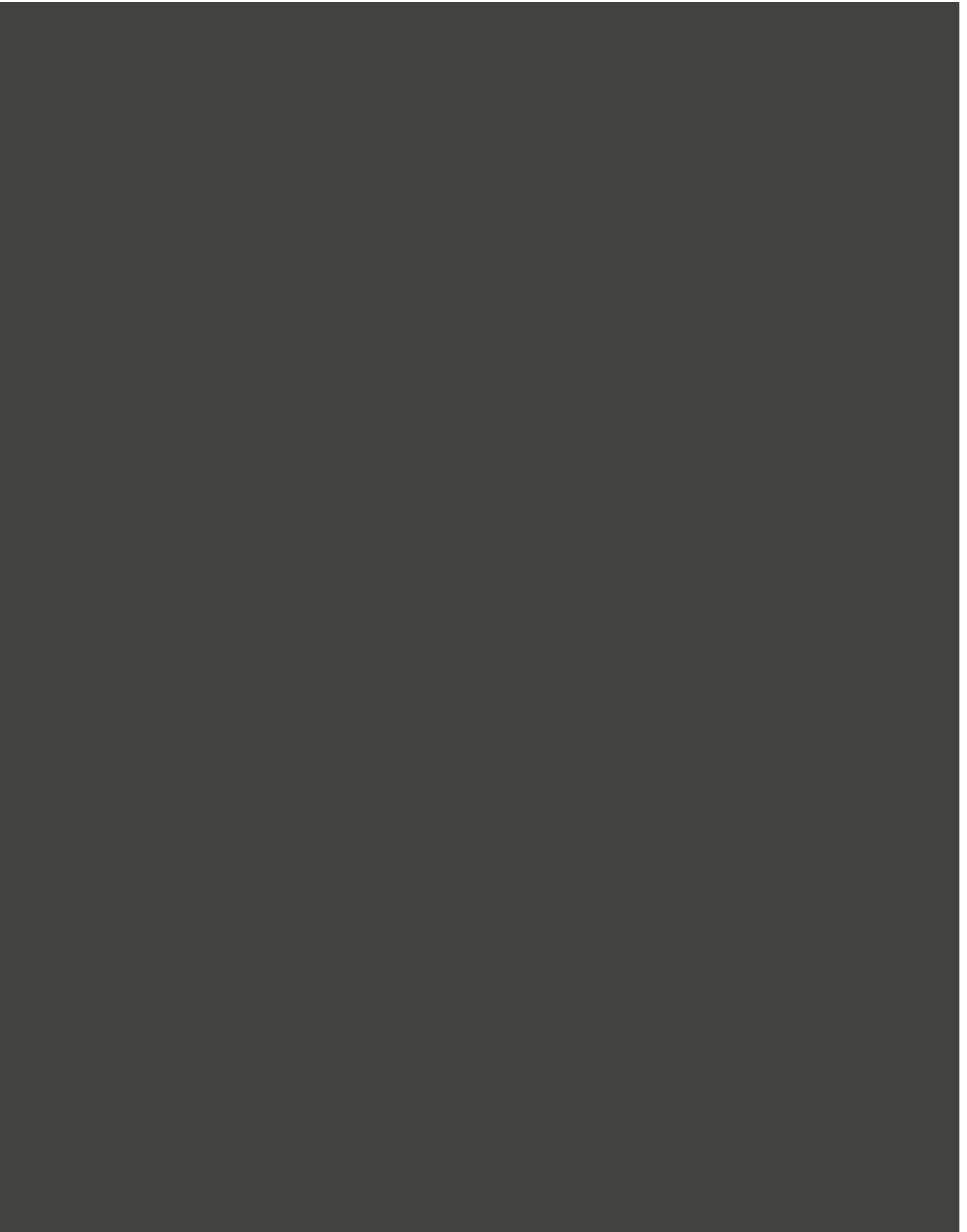

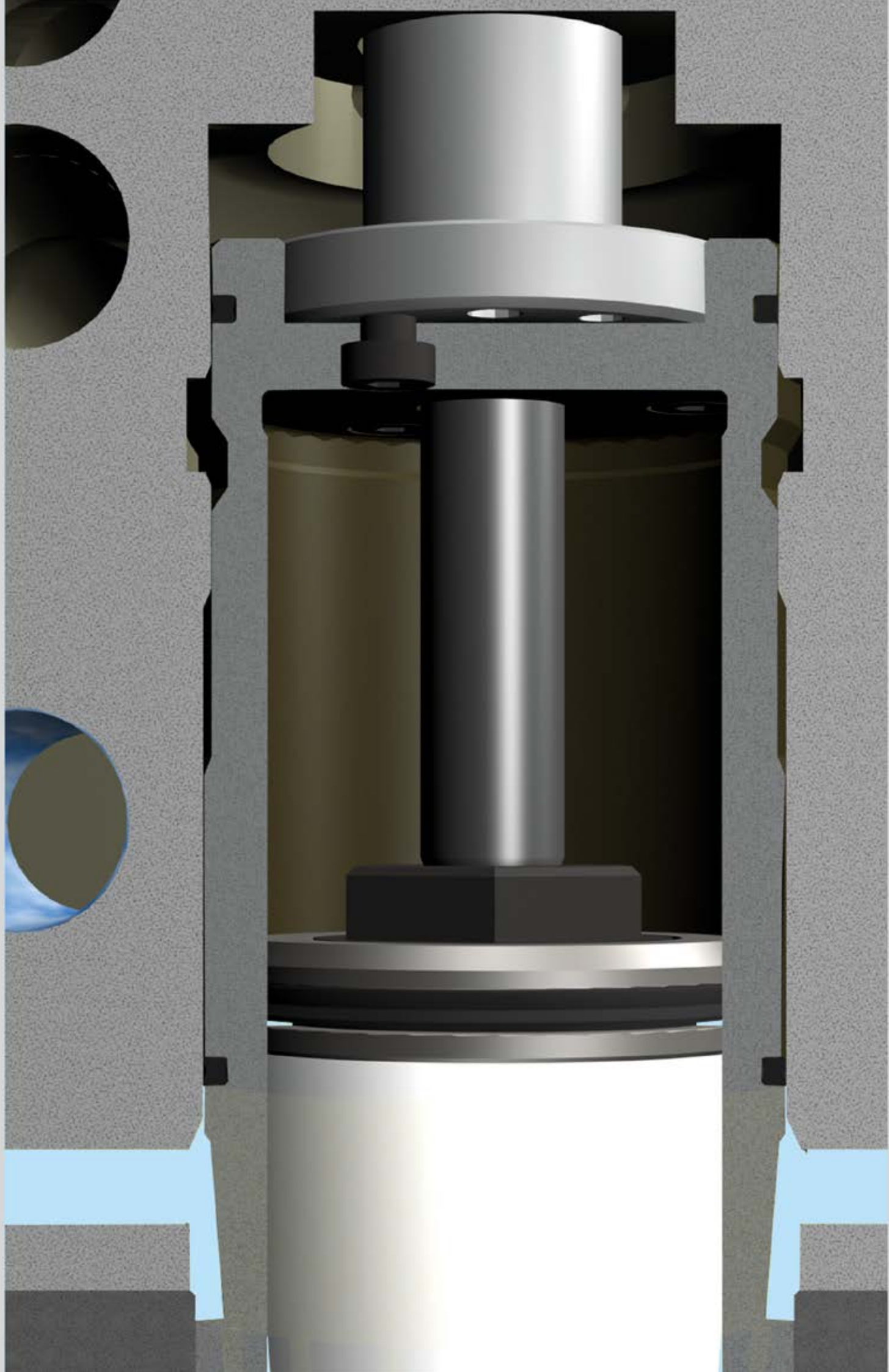

SERVICES.

TOOL OPTIMIZATION.

Your packaging not only needs to be visually convincing. But also, its production has to function smoothly. In order to provide you with the best support for this, we would be happy to optimize your tools and their components. And ensure process reliability. And productivity.

Choose suitable options for your tool optimization.

- Quality Gate: approval of tools.
- Optimization of tools. Functionality. Process reliability. Stackability of products.
- Pre-stretch plug optimization.
- Lid fit.

Why you should use our service.

- To receive know-how from a specialist in thermoforming.
- So you can increase the efficiency of your production.
- To get everything from a single source and thus save valuable coordination effort.

Perfect tools for perfect packaging. Benefit from the numerous advantages of this Marbach service.



PROCESS OPTIMIZATION.

SERVICE. WORLDWIDE.

There are many ways to increase your production performance. In addition to the perfectly fitting tool package, well-trained employees play just as important a role as the productive use of your machinery. And the correct handling of the used tool technologies.

For this reason, we offer you worldwide service. To increase your productivity. And save you time and money in the long term.

Choose suitable options for increasing your performance.

- Practical training courses on all aspects of tool technology and processes. In our technology center. Or at your site.
- Analysis and process optimization. With advanced measuring technology.
- Start-up and sampling of Marbach tools. In our technology center. Or at your site.
- Recommendation of actions needed to increase productivity.

Why you should use our service.

- For advanced training of your employees.
- You can increase the productivity of your thermoforming machines.
- You will be supported by experienced service technicians.

Take advantage of our expertise. And benefit in the long-term from an increase in productivity throughout your production. Enhance your performance.



Overview Information

Real-time data visualization with 1000 data points

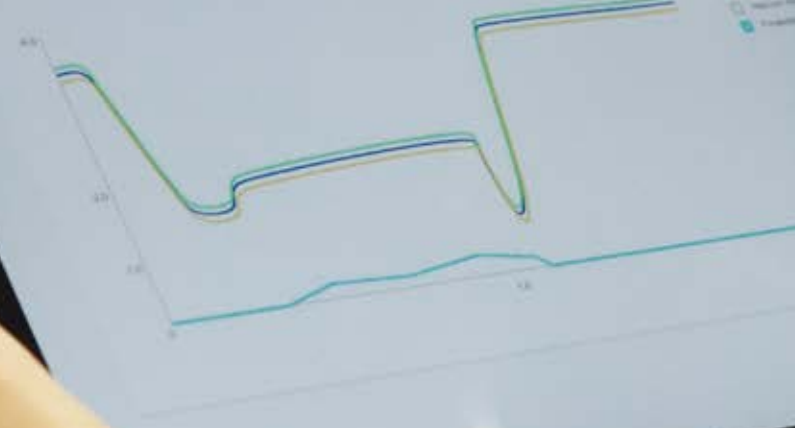

KMD 8

DIGITALIZATION. AND INDUSTRIE 4.0.

CONNECT|M. SMART TOOLS.

You want to optimize your tools and thermoforming processes? With CONNECT|M you get intelligent tools. CONNECT|M contains various modules and extensions for the process data monitoring of important tool and machine parameters (pressure, temperatures, movements, forces,...) which are measured by sensors in the tool.

Choose suitable options with CONNECT|M.

- Constant process data monitoring of various parameters via sensors in the tool.
- Remote support.
- Modular system. Retrofitting possibility.
 - Parallelism measurement.
 - Pre-installed sensors.
 - Parallelism control during running production.

Why you should use CONNECT|M.

- To be prepared for the future.
- Flexibility through modular design.
- Increased process reliability by creating a transparent process.
- Plug and Play.
- Simple start-up and change of tools. Quick set-up of tool parallelism.
- Reduction of wear. And increasing your tool life.
- Simple handling via the CONNECT|M app.

Digital Services from Marbach. Benefit from our know-how. And take the next step into the industry 4.0 with us.



DIGITALIZATION. AND INDUSTRIE 4.0.

CONNECT|AR. SMART SERVICE.

In the age of industry 4.0, we are leading the way as innovation drivers. With our digital solutions for thermoforming processes and services. This is why we are part of a virtual customer support project. With AR data glasses. We are building a network. Together with partners of the European Thermoforming Division.

With the help of Augmented Reality, we offer effective customer support.

Your possibilities with CONNECT|AR.

- Best support from experts. Worldwide. With data glasses.
- App available for iOS and Android.
- Connect via data glasses. Computer. Tablet. Or smartphone.
- Cloud service.

Why you should use our Digital Services.

- To be prepared for the future.
- Get support when you need it. Fast and uncomplicated.
- Save on travel costs. And time.

Augmented Reality Services from Marbach. Benefit from our know-how. And take the next step into the industry 4.0.

YOU.



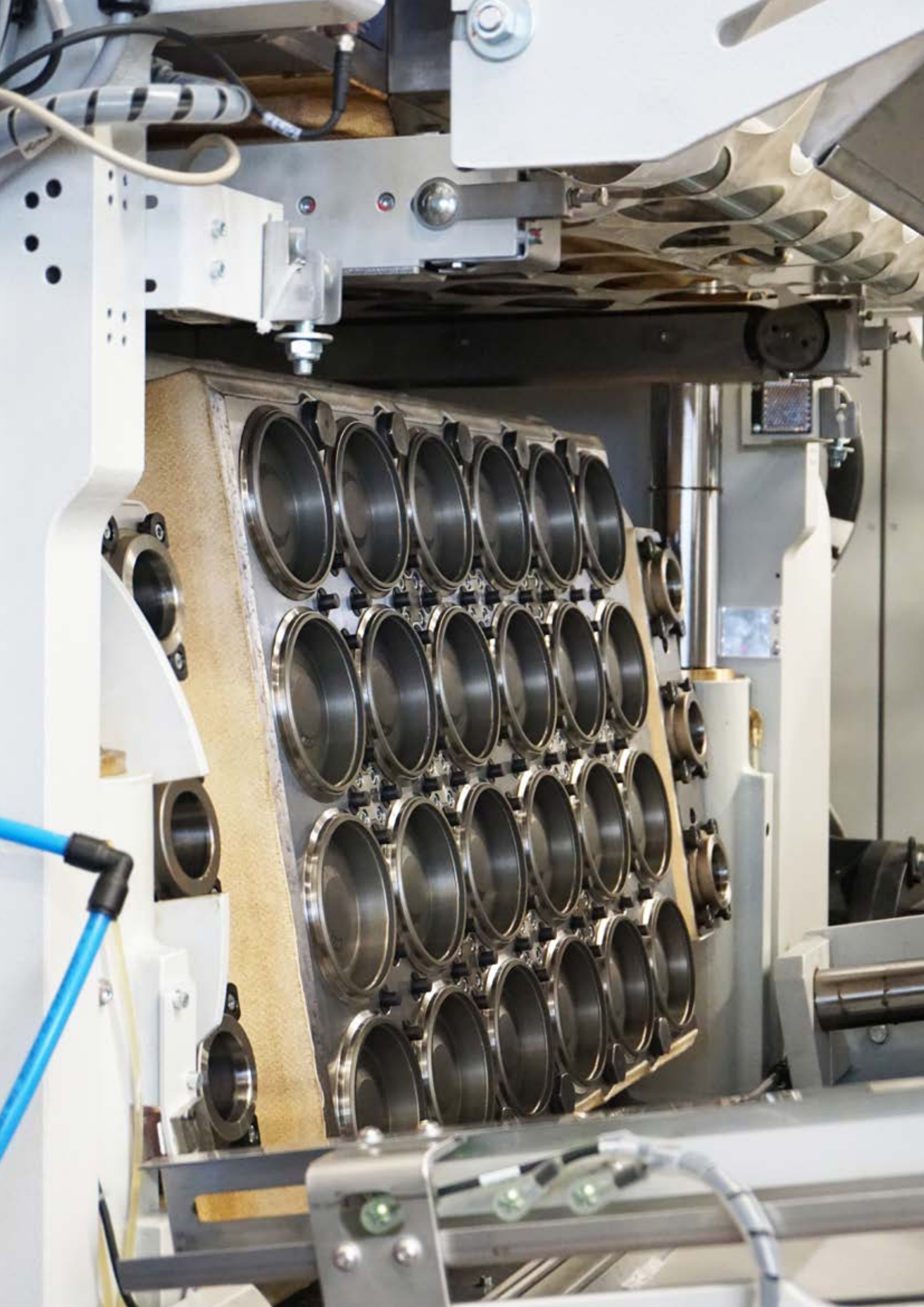

MARBACH SERVICE.

The Marbach team.

Our service technicians have many years of experience in the industry. They will support you with their expertise.

Please contact us:

- General inquiries: toolsales@marbach.com
- Service enquiries: toolservice@marbach.com

Our machinery in the technology center Heilbronn.

- Gabler M98 MAXX.
- Gabler M90. With T-IML option.
- Kiefel Speedformer KMD 85.

Our machine park allows us to test tools for numerous machines for you.

Match-metal tools on the Gabler M98 Maxx:

- Illig: 50k, 54k, 70k, 75k, 76k, 73k.
- Gabler: M60, M90, M92, M93, M98
- Kiefel: KTR4, KTR5, KTR6, KRT6.1
- WM: FT500, FT700

Steel-rule tools on the Kiefel KMD 85:

- Illig: RDK 54, RDK 80, RDKP 72
- Gabler: Focus 80, Focus 80IS, Focus 60
- Kiefel: KMD 52, KMD 60, KMD 75, KMD 78
- WM: FC 780

Leave the optimization of your packaging to us. Benefit from the numerous advantages of this Marbach service. And increase your performance.

PACKAGING. PERFORMANCE. YOU.

Marbach Group

Marbach Werkzeugbau GmbH

Karl-Marbach-Straße 1

74080 Heilbronn

Germany

phone +49 7131 918-0

toolsales@marbach.com

www.marbach.com

**PACKAGING.
PERFORMANCE.
YOU.**